

USER MANUAL

WARNINGS

- LED Light sources are extremely bright. Do not look directly into the LED beam to avoid damage to the eyes.
- The light source in this luminaire must only be replaced by the manufacturer or its service agent or a similar qualified person.
- Make sure that the barcode, model and serial number of the product are not damaged.
If these are not read or are worn out, your product will be out of warranty.
- In case of damage to the external twisted cable or cord of this luminaire;
must be replaced only by the manufacturer or its authorized service agent or equivalent qualified personnel in order to avoid a hazard.
- This luminaire is suitable for use at ambient temperatures between -20°C and +50°C.
- This luminaire is suitable for indoor use, not suitable for environments with explosive and corrosive gases.
- The luminaire should not be mounted on surfaces that will prevent natural air circulation or be covered. In order to prevent overheating that may occur during use, care should be taken to ensure that there is sufficient air space between the luminaire body and the surrounding objects.
- Disconnect the power before starting installation. The supply voltage of the luminaire is 230V AC 50-60Hz and the product must be connected to the ground line and a fuse and residual current relay of appropriate value must be installed on the line.
- Inappropriate voltage or connection type, high pulse energy discharges (such as lightning), mains power surges, unauthorized intervention to product components, modifications to the product will void the product warranty.
- To avoid damaging or abrading the cables, connect them in metal conduit and away from ceiling profile edges and sharp corners.
Do not use luminaires with damaged supply cables.
- Do not use solvent solvent chemicals for cleaning the product, clean with warm soapy water.
- The "Consumer" cannot be held responsible for any damage or injury caused by improper use and installation of the luminaire.
- This Led luminaire is suitable for Internal use only.

Markings :

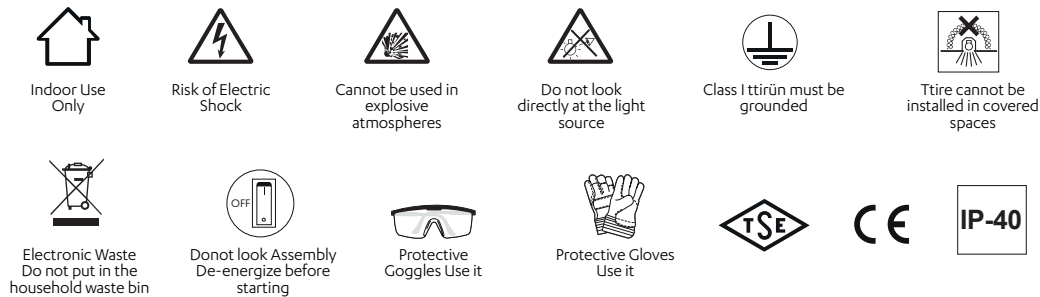

Hand tools to be used :

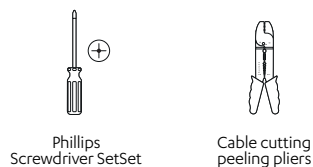

ASSEMBLY INSTRUCTIONS

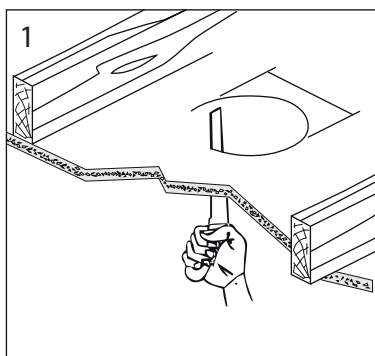

Open the ceiling to be mounted in accordance with the downlight cutting diameter you have selected.

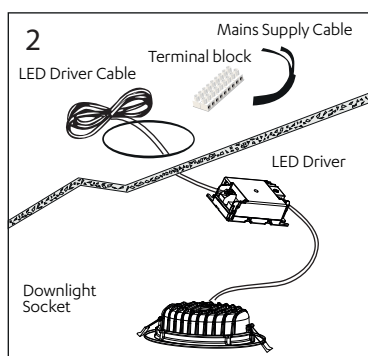

Connect the mains supply cable and Led driver output cable with a suitable terminal block in accordance with the cable colors.

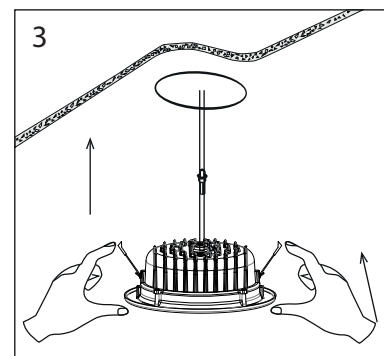

Energize the luminaire by plugging in the led downlight and driver output socket. After making sure that the product is working, lift the springs on the downlight backwards and release it freely into the space opening to the ceiling.

ASSEMBLY INSTRUCTIONS

CEILING CUT MEASUREMENTS

5 INCH

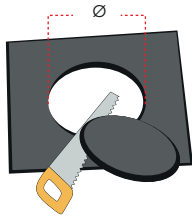

Ø=160mm

CONNECTION TYPE

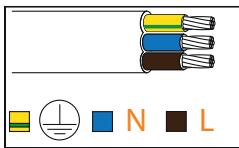

Brown L= Blue N= Neutral and
 Yellow Green= Earth
 so that the clamp is related
 Connect them so that they
 coincide with the markings.

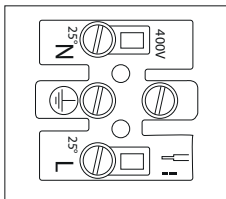

Connect the field power supply
 cable and the cable coming from
 the LED driver with each other
 with screw or push terminals of
 suitable size.

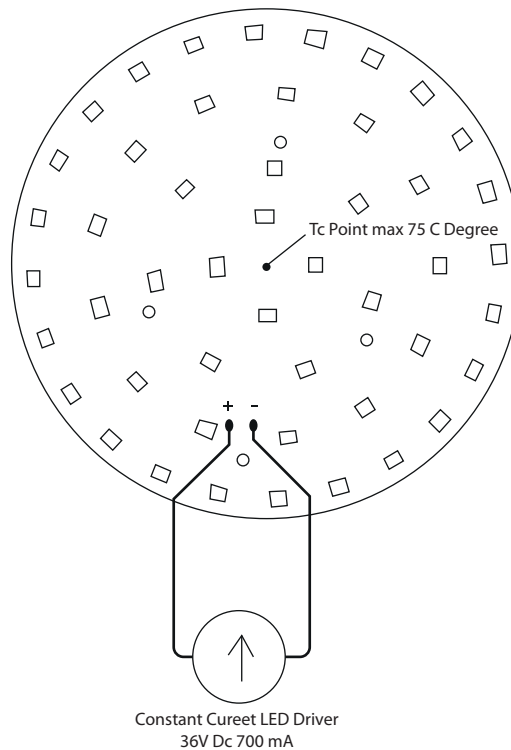

TECHNICAL SPECIFICATIONS

Item Code	Power (W)	Luminaire Lumen (lm)	Color Temperature (K)	Efficiency (lm/W)	Dimensions (LxWxH)	Qty/Carton	Carton Size (LxWxH)	G.W/Carton
LDL10.021	15W	1.500	3000/4000/6500	100lm/W	205X50mm	1	210x440x420mm	7.5 kg
LDL10.024	18W	1.800	3000/4000/6500	100lm/W	205X50mm	1	210x440x420mm	7.5 kg